

## Chapter 13 MODULATION

*Modulation* is the “piggy-backing” of a signal containing information onto another signal, called a *carrier*, which usually has a constant, and much higher frequency. The modulated carrier, now containing the information present in the original signal, can be transmitted from one place to another, and the original information recovered at the destination.

Why use modulation? The answer is that it’s a convenient and efficient way to transmit signals. Consider this: an audio signal, say from a microphone, contains meaningful information from frequencies of tens of Hz to, say, 20 kHz. The bandwidth of this signal spans almost zero (dc) to 20 kHz.

Now, while it’s easy to send the signal along a cable, perhaps to a public address amplifier, we might want to broadcast it over a large area using radio waves. It is possible to just use waves at the frequency of the signal –that is, pass the signal directly to an antenna –but it isn’t a very practical idea, for (at least) the following reasons:

- It is difficult to build an efficient antenna for audio frequencies.
- There is too much extraneous noise and interference at audio frequencies that the system would pick up.
- If somebody else wanted to do the same, they couldn’t broadcast at the same time.

The solution is to use a much higher frequency carrier signal, which we then modulate with the audio signal. This has a number of advantages:

- We can choose a convenient frequency for the carrier. This might be, for example, because we can make smaller and more convenient antennas, or to take advantage of particular wave propagation effects at certain wavelengths.
- It turns out that the *fractional bandwidth* (that is, the bandwidth divided by the centre frequency) of the transmitted signal will be much less. This is also advantageous. For example:
  - \* Antennas (and radio frequency amplifiers, and many other components) are easier to design for relatively small frequency ranges.
  - \* A number of users, each with slightly different carrier frequencies, can transmit at the same time (that is, we can have a number of simultaneous frequency *channels*).

**Types of modulation**

A carrier, usually a simple sine wave, contains no information in itself. To modulate a carrier, one of its properties (amplitude, frequency or phase) is varied by the information-containing signal. This gives us three possibilities:

- Amplitude modulation (AM), where the amplitude or strength of the carrier is varied.
- Frequency modulation (FM), where the frequency of the carrier is varied.
- Phase modulation (PM), where the phase of the carrier is varied.

It actually turns out that FM and PM are very close relatives (in fact you “can’t have one without the other..”). However, I won’t say any more about PM here. You will have probably met the terms AM and FM in connection with ordinary radio broadcasts. Commercial radio stations are licensed to use carrier frequencies between about 500 kHz to 1600 kHz using amplitude modulation (the “AM” band), and frequencies between 88 and 108 MHz using frequency modulation (the “FM” band).

**Amplitude Modulation**

The simplest form of AM is to simply turn the carrier on and off. This is shown in the diagram below and is used, for example, in:

- Optical fibres, where the carrier is at IR frequencies (note that an IR wavelength of 1000nm corresponds to a frequency of  $3 \times 10^{14}$  Hz, or 100,000 GHz).
- IR remote controls. Here the scheme is a little more complicated. The IR radiation is first turned on and off at a frequency of about 40 kHz. This 40 kHz signal is then itself used as a carrier (it would be termed a “*subcarrier*”) which is modulated by a series of pulses, in sequences corresponding to codes for the various control functions. This scheme helps to avoid IR interference from things like incandescent and fluorescent lamps, which flicker at 100 Hz and other harmonics of the 50 Hz mains frequency.

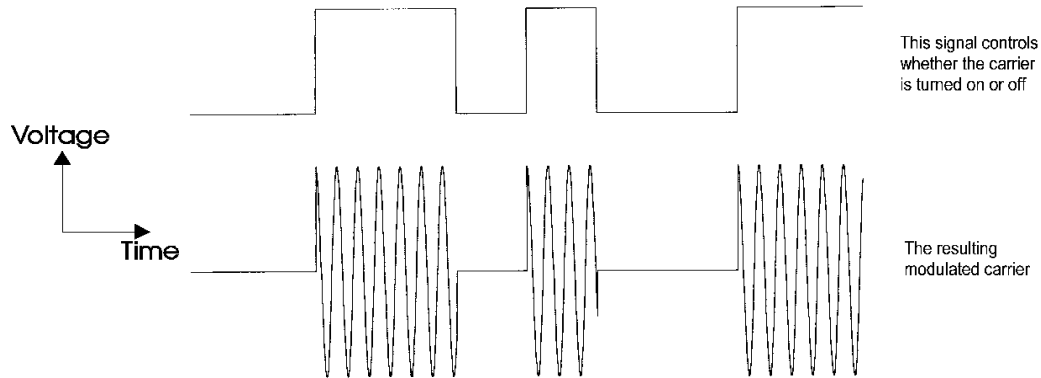

Figure 13-1 Simple amplitude modulation. Here the carrier is simply turned on or off by the modulating signal.

In the usual case (like AM radio), the modulation is done in a continuous fashion, as shown below. Notice that the “envelope” of the carrier has exactly the same shape as the modulating signal.

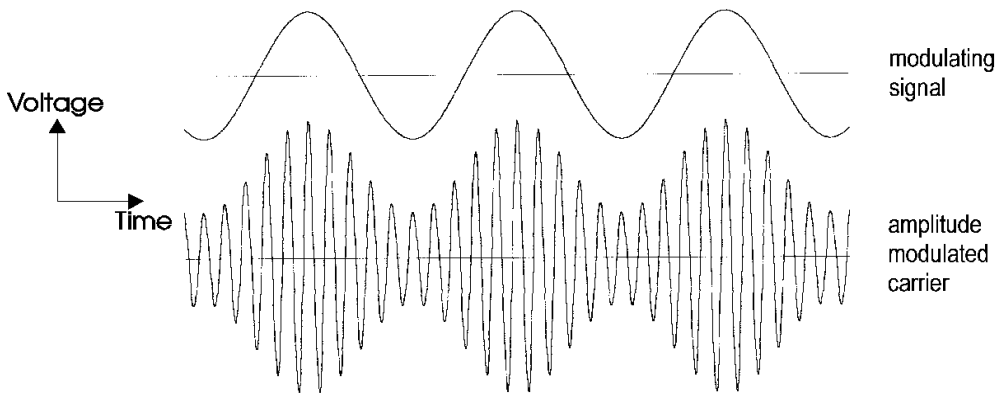

Figure 13-2 Amplitude modulating a carrier with a sine wave.

The voltage waveform of the modulated carrier shown in figure 13-2 can be described mathematically by the expression

$$v(t) = A_c \cos(2\pi f_c t) \{1 + m \cos(2\pi f_m t)\}$$

where

- $A_c$  = the peak carrier amplitude (with no modulation)
- $f_c$  = the carrier frequency
- $f_m$  = the modulation (or *modulating*) frequency
- $m$  = the *modulation index*

The *modulation index* is a value between 0 and 1 describing the “degree of modulation” of the carrier. If  $m = 0$  there is no modulation, while  $m = 1$  is the maximum modulation that can occur without distortion. This is

because the instantaneous amplitude of the carrier can in practice never be less than zero, as would be required for  $m > 1$  (this is referred to as *overmodulation*). Examples for some values of  $m$  are shown below.

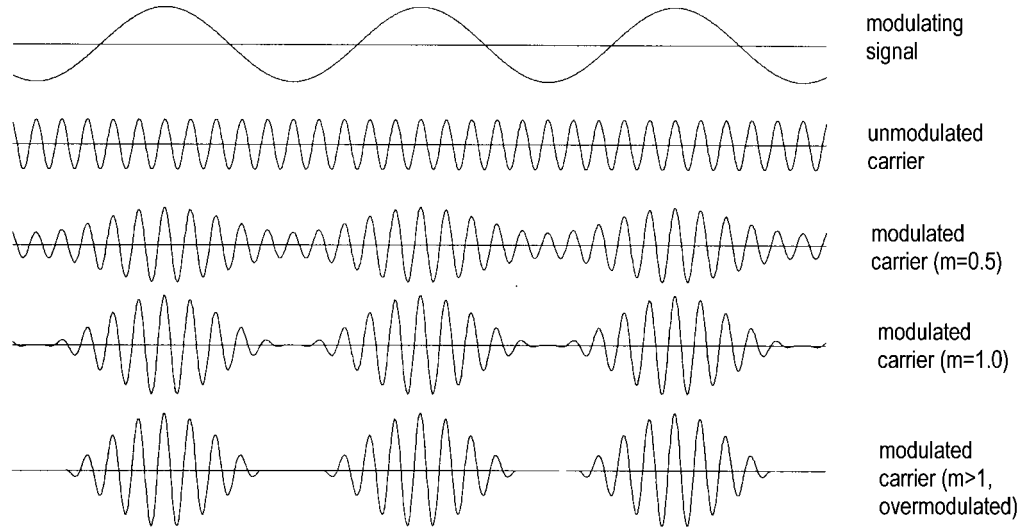

Figure 13-3 Examples of amplitude modulation of a carrier by a sine wave for different values of modulation index,  $m$ . Note that when  $m > 1$  the carrier is turned off for a short time and information is lost.

AM radio stations must be careful not to overmodulate their transmissions, and usually have some active means of preventing this. Although overmodulation is generally not damaging to equipment, it does produce severe distortion in the received signal.

The diagram below shows a way of measuring the modulation index for an AM carrier modulated by a simple sine wave. If  $V_{\max}$  and  $V_{\min}$  are the maximum and minimum carrier peak amplitudes as shown, then the modulation index  $m$  is given by

$$m = \frac{V_{\max} - V_{\min}}{V_{\max} + V_{\min}}$$

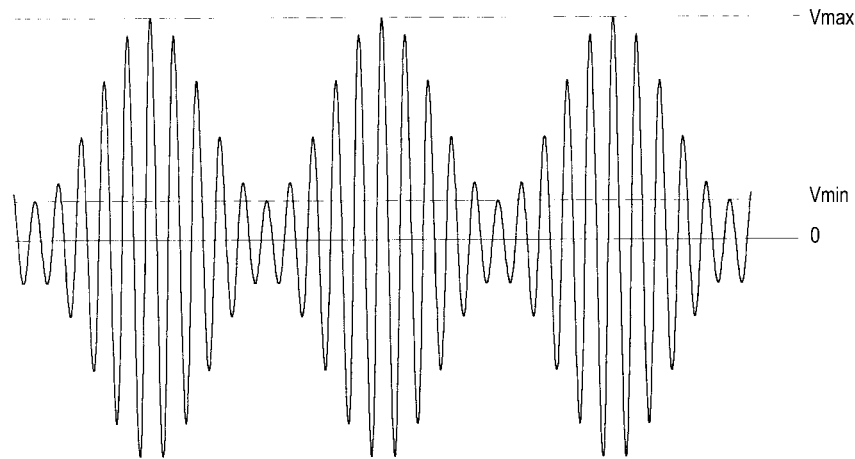

Figure 13-4 Calculating the modulation index for AM (see text).

### Spectrum of an AM signal

An unmodulated carrier is simply a sine wave—that is, it contains only one frequency, so its spectrum will consist of a single line, as shown in figure 13-5 (left) below. What happens when it's modulated? A look back at figure 13-2 might convince you that an AM signal is no longer a single sine wave, so its spectrum must have changed. Figure 13-4 (centre) shows the result, if the modulating signal is also a simple sine wave, and  $m = 1$ .

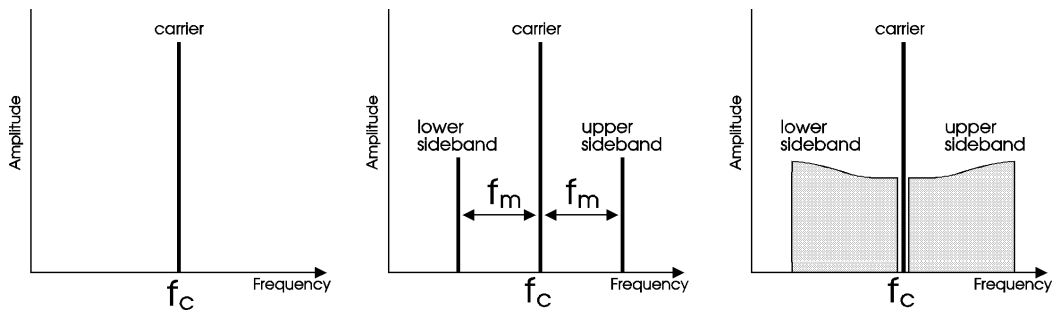

Figure 13-5 Spectra for an unmodulated carrier (left) and a carrier modulated by a single sine wave of frequency  $f_m$  (centre). In practice the modulating frequency will contain a range of frequencies, and the sidebands will be broad (right).

The spectrum now consists of the original carrier frequency, plus two new (“upper” and “lower”) *sidebands* spaced a distance  $f_m$  above and below the original carrier frequency<sup>1</sup>. For example, if the carrier frequency is 1000 kHz (1 MHz) and the modulating frequency is 1 kHz, then the sidebands will occur at 999 kHz and 1001 kHz –that is, at  $(f_c - f_m)$  and  $(f_c + f_m)$ . If the modulating signal contains a range of frequencies up to, say, 10 kHz, then the sidebands will appear something like figure 13-5 (right). So the amplitude modulated carrier now occupies a total bandwidth of  $2f_m = 2 \times 10 \text{ kHz} = 20 \text{ kHz}$ .

---

**\*Aside:** *What produces the sidebands in AM?*

A little mathematics indicates why an AM signal consists of a carrier and two sidebands. The right-hand side of the equation

$$v(t) = A_c \cos(2\pi f_c t) \{1 + m \cos(2\pi f_m t)\}$$

can be expanded (using some trig identities) as:

$$\begin{aligned} v(t) &= A_c \cos(2\pi f_c t) + mA_c \cos(2\pi f_c t) \cos(2\pi f_m t) \\ &= A_c \cos(2\pi f_c t) + 0.5mA_c \{\cos(2\pi[f_c - f_m]t) + \cos(2\pi[f_c + f_m]t)\} \\ &= A_c \cos(2\pi f_c t) \\ &\quad + 0.5mA_c \cos(2\pi[f_c - f_m]t) + 0.5mA_c \cos(2\pi[f_c + f_m]t) \end{aligned}$$

Notice that this last expression consists of three sine waves –at the frequencies of the carrier, and the lower and upper sidebands. Notice also that for  $m = 1$  (full modulation), the amplitude of each of the sidebands is half that of the carrier. There is thus one-quarter of the carrier power in each sideband.

---

In fact, AM stations use an audio bandwidth of about 9 kHz, and the spacing between stations is 9 kHz in Australia. Since this audio bandwidth should require a radio frequency (*RF*) bandwidth of at least 18 kHz for each station, how can this work? The sidebands from adjacent AM stations should overlap and hence interfere with one another! The answer

---

<sup>1</sup> It is worth realising that the spectrum of a signal is always an **average** over some time interval. For example, consider the spectrum of a carrier which is amplitude modulated by a single sine wave, as in figure 13-4. If we take a couple of cycles of this signal near its minimum amplitude, the spectrum will clearly be different (in magnitude) from the spectrum when the signal is near its maximum. The sidebands discussed in connection with AM only show up in the spectrum of very many cycles of the amplitude modulated carrier, and the same is true for the spectrum of a frequency modulated carrier, as discussed later.

is that AM stations in one part of the country are not allocated adjacent channels. However, interference can certainly occur at night when better propagation conditions allow the simultaneous reception of local and quite distant stations on the same or adjacent frequencies.

Contrary to popular belief, AM transmissions can be of subjectively quite high quality, even in spite of their restricted audio bandwidth. The main stumbling block is AM receivers, which are almost invariably constructed with demodulators of abysmal quality, even in some rather expensive audio systems! However, it is certainly true that the ultimate quality attainable with AM radio falls rather short of that which FM can deliver.

One significant drawback of AM transmissions is that they tend to be rather sensitive to *impulsive* interference (that is, noise “spikes”) which can be caused by, say, lightning or car ignition noise, since the information is contained in the instantaneous amplitude of the signal.

### Frequency modulation

The basic idea of FM is shown in the diagram below. Here the carrier **frequency** is controlled at each instant by the voltage of the modulating signal. In this example, more positive modulating signal voltages increase the carrier frequency, while more negative voltages decrease it.

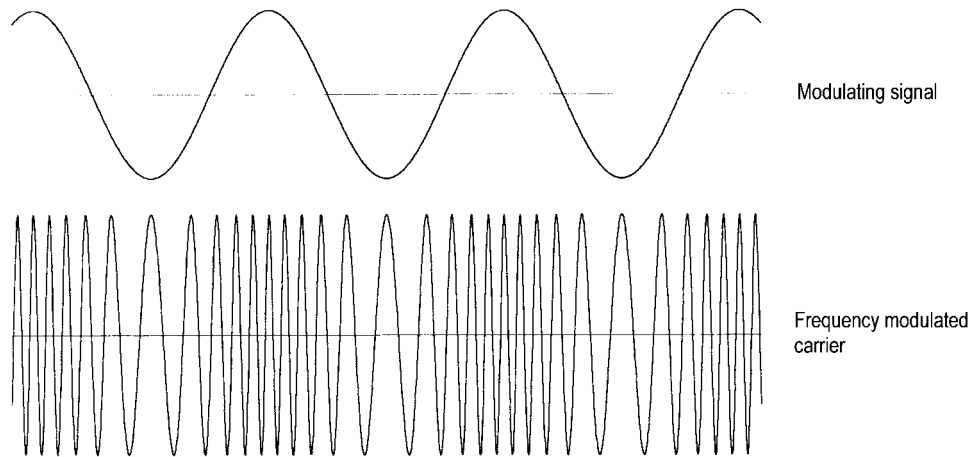

Figure 13-6 With frequency modulation, the instantaneous carrier frequency is controlled by the modulating signal.

The voltage of the modulated carrier in the FM case can be mathematically described by the expression

$$v(t) = A_c \cos\{2\pi f_c t - m \sin(2\pi f_m t)\},$$

where the symbols have the same meanings as for AM, and  $m$  is once again the *modulation index*, although its meaning for FM is somewhat different. It turns out that the modulation index for FM is given by

$$\text{modulation index } (m) = \frac{\text{peak carrier deviation } (\Delta f)}{\text{modulating frequency } (f_m)},$$

where the *peak carrier deviation* ( $\Delta f$ ) is **the maximum frequency shift away from  $f_c$**  that the carrier experiences as it cycles higher and lower (this will occur when the modulating voltage is a maximum or minimum).

Modulating the **frequency** of a carrier rather than its amplitude has some advantages, relating mainly to noise performance, although the tradeoff is that a good quality commercial FM transmission requires significantly more bandwidth than an AM transmission. A narrow-band version of FM can be used for voice communications where the quality does not need to be so high, and here the bandwidth requirements can be similar to AM.

Note the following points:

- There is no “overmodulation” situation with an FM signal, but...
- As the modulation index is increased, the signal occupies more bandwidth.
- As the modulation index is increased, the signal becomes more resistant to interfering noise; that is, the effective S/N ratio can be larger.

The last two factors can probably be summed up as: *a higher modulation index is a good thing, as long as it doesn't use up too much bandwidth.*

Commercial FM broadcasting in Australia uses a peak deviation of  $\pm 75$  kHz together with a maximum modulating frequency of 15 kHz (the maximum audio bandwidth for FM). The minimum modulation index is thus 5, which still gives quite good noise immunity. TV stations also use FM for the sound part of their signals. For TV the peak deviation is  $\pm 50$  kHz, not too different from FM radio, and the sound from TV channels 3, 4 and 5 (which fall in the 88-108 MHz FM radio band) can be received with an ordinary FM tuner.



Adjacent FM broadcasting stations are spaced 200 kHz apart in frequency. This allows for the standard peak deviation of  $\pm 75$  kHz (i.e. 150 kHz peak-to-peak) with some “guard band” at each end.

### Spectrum of an FM signal

The spectrum of an FM signal is rather messy. As with AM, the modulation process causes sidebands to be present at frequencies above and below the carrier. However, in general there are a lot more of them, all spaced at multiples of  $f_m$  from the carrier. As a result, the bandwidth needed to accommodate an FM signal is considerably greater than that for an AM signal having the same modulating frequency. The only exception is when the modulation index is less than about 1. This is referred to as *narrow band FM* (NBFM), and most of the information is contained within the range of the first upper and lower sidebands. In this case a total bandwidth of  $2f_m$  is adequate for transmission.

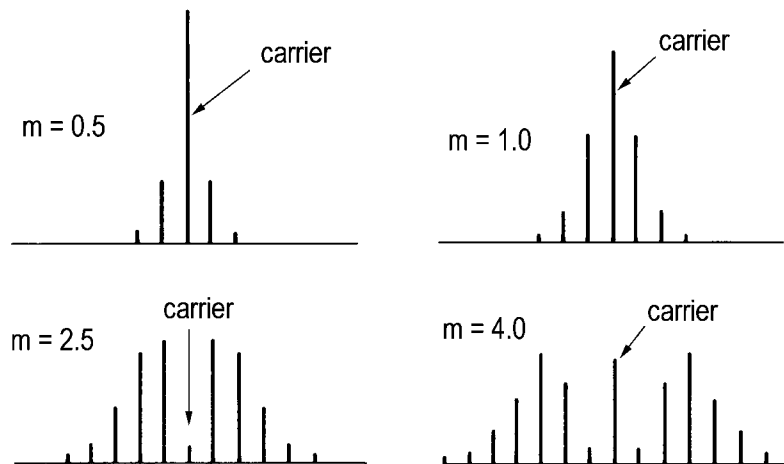

Figure 13-7 The spectrum of a frequency modulated carrier for various values of the modulation index,  $m$ . In these examples the modulating signal is a simple sine wave of constant frequency. A “forest” of sidebands is produced, spaced a frequency  $f_m$  apart. Messy!

In general, the total bandwidth required for transmission of an FM signal is given by

$$\text{Bandwidth} = 2 [ m + 1 ] f_m \quad \text{Hz}$$

---

\* **Aside:** *Where do all the FM sidebands come from?*

The complicated sideband structure of FM arises directly from the expression used to describe the modulated carrier:

$$v(t) = A_c \cos\{2\pi f_c t - m \sin(2\pi f_m t)\}$$

Although this expression looks relatively innocuous, it is not! Notice that if it is expanded, the sin and cos terms are **not** simply multiplied together; rather, we end up with terms of the form

$$\cos\{m \sin(2\pi f_m t)\} \quad \text{and} \quad \sin\{m \sin(2\pi f_m t)\}$$

That is, the “cos of a sin...” etc. These expressions turn out to represent an infinite sum of components at the sideband frequencies and some rather messy mathematical (Bessel) functions, the details of which we will not go into here.

---

### **Demodulation of AM and FM signals**

Demodulation (or *detection*) is the process of recovering the original modulating signal from a modulated carrier. I have not discussed any practical techniques for modulation, but, just for interest, a few brief comments about demodulation techniques might be appropriate.

As I've mentioned before, AM is really the “poor cousin” in terms of quality of consumer electronics. AM detectors almost invariably use *envelope detection* and consist of a simple diode *rectifier* circuit, which, roughly speaking, “chops off” either the positive or negative half of an AM signal. The resulting waveform is then smoothed, giving an output signal which approximates the shape of the envelope of the modulated carrier. Better (and rather more complex) AM detectors are available, but tend only to be used in rather exotic receivers.

These days FM detectors almost universally use a circuit called a *phase-locked loop* (PLL), an extremely useful device which finds its way into all sorts of electronic systems. Briefly, it consists of an oscillator whose frequency can be varied by means of a voltage (that is, a *voltage-controlled oscillator* or *VCO*), and a feedback circuit. While its operation is a little too complex for us to discuss here, students who go on to do Electronics III will eventually meet it head on!

## Chapter 14 FREQUENCY CONVERSION and OTHER TOPICS

### Frequency conversion

We saw previously that for AM, two sidebands were formed at frequencies just above and below the carrier frequency. For a carrier which is amplitude modulated with a range of audio frequencies, each sideband looks just like a copy of the spectrum of the original audio signal which modulated the carrier. In essence, the original signal at audio frequencies has been "shifted up" in frequency. In a real sense, the information contained in the original signal has not changed in any way by being shifted to a new frequency, and in the case of AM can be recovered by the process of demodulation.

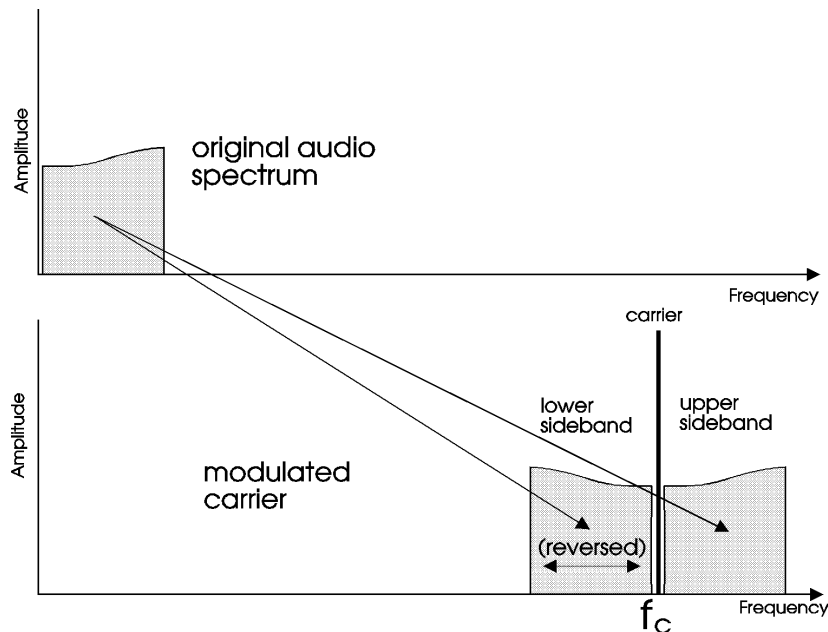

Figure 14-1 The sidebands of an AM signal are just copies of the modulating signal, but shifted in frequency by an amount equal to the carrier frequency,  $f_c$ . In addition, the lower sideband is reversed in frequency.

There are many situations where we need to take a single frequency or range of frequencies present in a signal and shift these frequencies by a certain amount. This might be, for example, so that many different signals can occupy slightly different frequencies to allow many users or services to efficiently share a relatively restricted frequency band. This was commonly used, for example, with analog telephone voice signals, where many individual signals were "aggregated" into a single signal with

much larger bandwidth for transmission to other locations. This technique is referred to as *frequency-division multiplexing*, or *FDM*. Today, since the voice signals are converted to digital form, there are much more efficient ways of sharing a transmission channel amongst phone users.

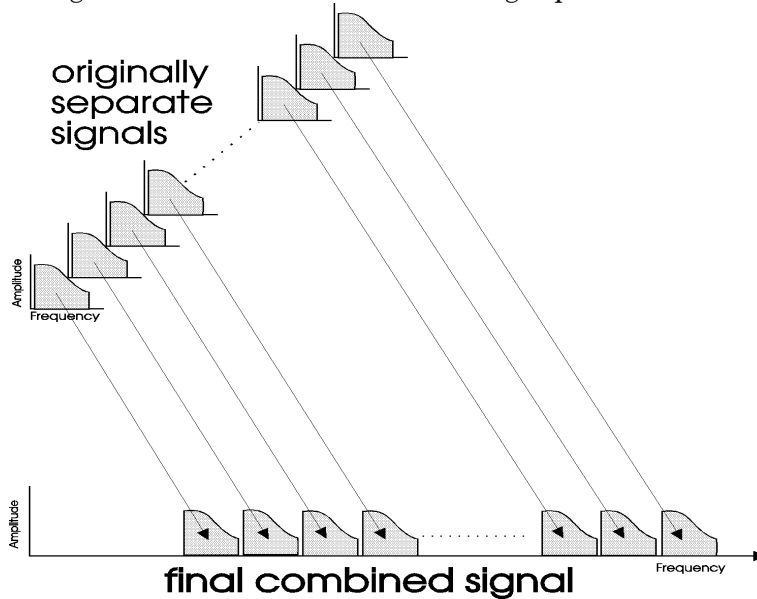

Figure 14-2 Frequency division multiplexing (FDM). A number of signals (perhaps telephone voice) are individually shifted up by different amounts and added together to form a combined, but wider band, signal.

The technique of frequency shifting, or frequency *conversion*, is commonly used as one part in a chain of various signal processing operations, particularly in telecommunications. Although it occurs naturally in the process of amplitude modulation, it is also possible to perform frequency conversion as a separate operation.

In order to shift a signal containing a frequency  $f_1$  by an amount  $f_2$ , a second sinusoidal signal at frequency  $f_2$  is used. The voltages of the two signals are then **multiplied** (quite literally) together. This process creates two new signals, at frequencies  $(f_1 + f_2)$  and a  $(f_1 - f_2)$ ; that is, at the *sum* and *difference* frequencies. We need a little maths to see how this comes about:

Suppose signal 1 is:  $v_1(t) = A_1 \cos(2\pi f_1 t)$

And signal 2 is:  $v_2(t) = A_2 \cos(2\pi f_2 t)$

Then signal 1 multiplied by signal 2 is:

$$v_1(t) \times v_2(t) = A_1 \cos(2\pi f_1 t) \times A_2 \cos(2\pi f_2 t)$$

Using the trig identity  $\cos A \times \cos B = \frac{1}{2}(\cos[A+B] + \cos[A-B])$ , we get

$$\begin{aligned} v_1(t) \times v_2(t) &= 0.5 A_1 A_2 \{\cos(2\pi[f_1 + f_2]t) + \cos(2\pi[f_1 - f_2]t)\} \\ &= 0.5 A_1 A_2 \cos(2\pi[f_1 + f_2]t) + 0.5 A_1 A_2 \cos(2\pi[f_1 - f_2]t) \end{aligned}$$

Note that this is now a simple sum of two sinusoidal signals. One of the pair of new signals (either at frequency  $[f_1 + f_2]$  or  $[f_1 - f_2]$ ) is then removed, usually by means of a filter, leaving the other.

**Example 14-1:** Two signals at frequencies of 1.5 MHz and 2.0 MHz are mixed (multiplied) together. What new frequencies are produced?

*Answer:* Mixing produces the sum and difference frequencies, which are:

$$1.5 + 2 = 3.5 \text{ MHz, and } 2.0 - 1.5 = 0.5 \text{ MHz.}$$

Note that taking  $1.5 - 2.0$  MHz for the difference would give us a **negative** answer. Mathematically, this turns out to be OK, but for our purposes we can just assume that the difference is always positive.

The whole business of multiplying one signal by another for the purpose of frequency conversion is often referred to as *mixing*, and a circuit which performs the multiplication is called a *mixer*. Don't confuse this with, for example, the term "mixing" of signals used in sound recording (it is certainly ambiguous). Frequency conversion involves the **multiplication** of two signals, while sound mixing involves the **addition** of two signals, a quite different process. When two signals are simply added together, **no new frequencies are produced**.

---

**\*Aside:** *Real mixers for frequency conversion*

In actual fact, it is difficult to build circuits which **precisely** multiply two signals together. Real mixers (and there are many different circuits) often rely on the fact that if a circuit is nonlinear<sup>1</sup>, then it will actually do **some** multiplication if two signals are simply added together and then passed through it. This process usually creates lots of other unwanted frequencies as well, but these can usually be filtered out.

---

<sup>1</sup> A nonlinear circuit is one which doesn't behave like a perfect amplifier, where the output signal is exactly proportional to the input signal.

Although frequency conversion is often used together with a number of other signal processing techniques as part of larger systems, it is used occasionally by itself to achieve a specific goal. Two examples are as follows:

- Communications satellites:** Basically, these work by taking a band of frequencies transmitted from one place on the earth and re-transmitting them to somewhere else. The band of frequencies may contain a variety of signals, modulated by various means –it doesn't really matter, it's just a "section of spectrum". Now, the band of frequencies received by the satellite is shifted in frequency before being re-transmitted back to earth. This is mainly to avoid transmitting and receiving simultaneously at the same frequency, which causes other problems. The frequency shift is accomplished in the manner just described. The electronic systems which perform the frequency shift and re-transmission are called *transponders* or *repeaters*. There are usually a number of separate transponders on a communications satellite, all operating at slightly different frequencies. These are "rented out" to various users.

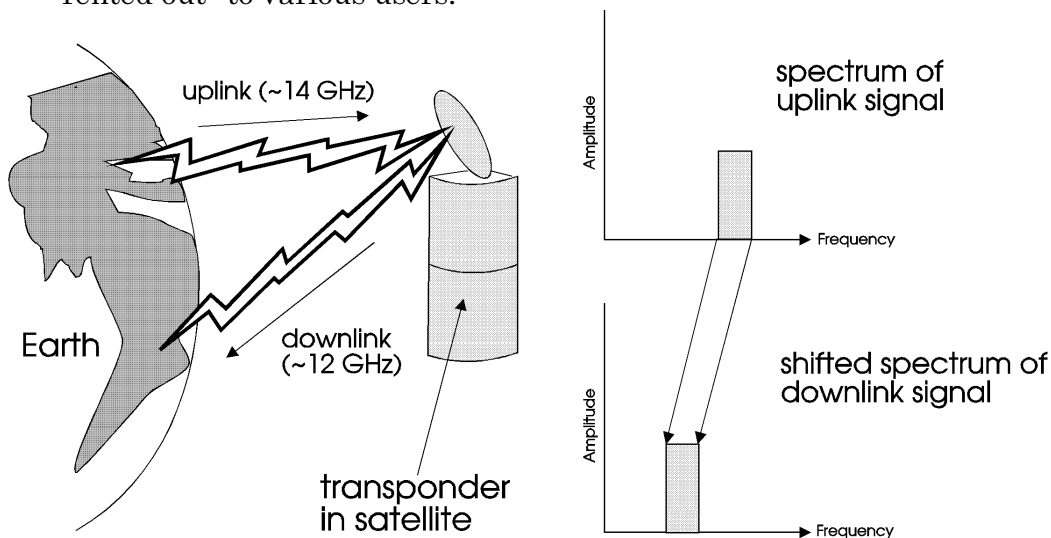

Figure 14-3 A satellite transponder receives signals over a band of frequencies, shifts them in frequency and re-transmits them.

- Curing feedback in public address systems:** You have probably heard a public address system "howl" due to excessive feedback from the loudspeakers back to the microphone. This occurs because the whole system, comprising the microphone, amplifier, room and

loudspeakers has a "resonance", or narrow range of frequencies over which the gain is extremely high. One way of reducing this annoying effect is to slightly shift the frequency of the signals from the microphone before they are amplified, so that the sound from the loudspeakers is at a slightly different frequency to that originally picked up by the microphone. Provided the frequency shift is only very small, say a few Hz, it is not too noticeable to most people's ears.

### Automatic gain control (AGC)

This is a signal processing technique which ensures that the amplitude of a signal stays, on the average, reasonably constant. It uses feedback, which you have already met. However, what is "fed back" is some sort of average of the **amplitude** or "level" of the signal, not the actual signal itself. The principle is illustrated in the diagram below.

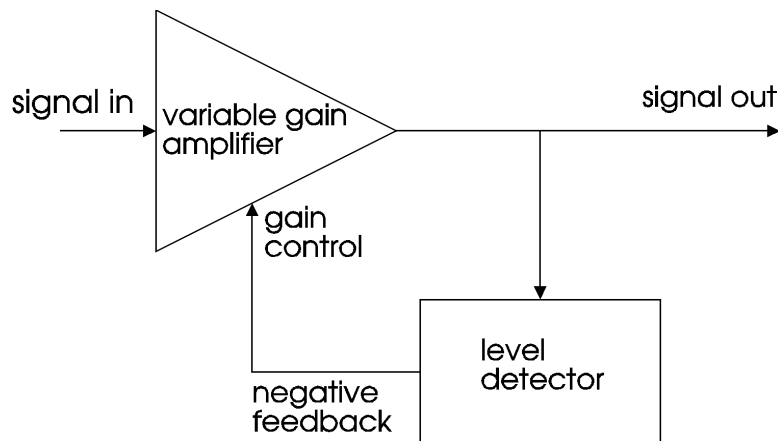

Figure 14-4 Principle of operation of an automatic gain control (AGC).  
Feedback ensures that the amplitude of the output signal is held relatively constant.

The amplifier at the left of the diagram has a gain which can be varied electronically, say, by varying a certain dc ("control") voltage. For example, the amplifier gain might be +10 dB with a control voltage of +1 volt, and +20 dB for a control voltage of +2 volts, and so on.

The amplitude of the voltage at the output of the amplifier is continuously measured and averaged over a short period of time by the *level detector*. Its dc output voltage is then fed back to control the gain of the amplifier. The net effect of all this is that the amplitude of the output voltage from

the amplifier can remain reasonably constant for a wide range of input signal amplitude.

This is illustrated by the graph below for a typical AGC system. Here the output voltage is almost constant for input voltages of about 1 volt or greater. (Below this, the system “runs out of steam”, since the variable gain amplifier cannot provide enough gain.)

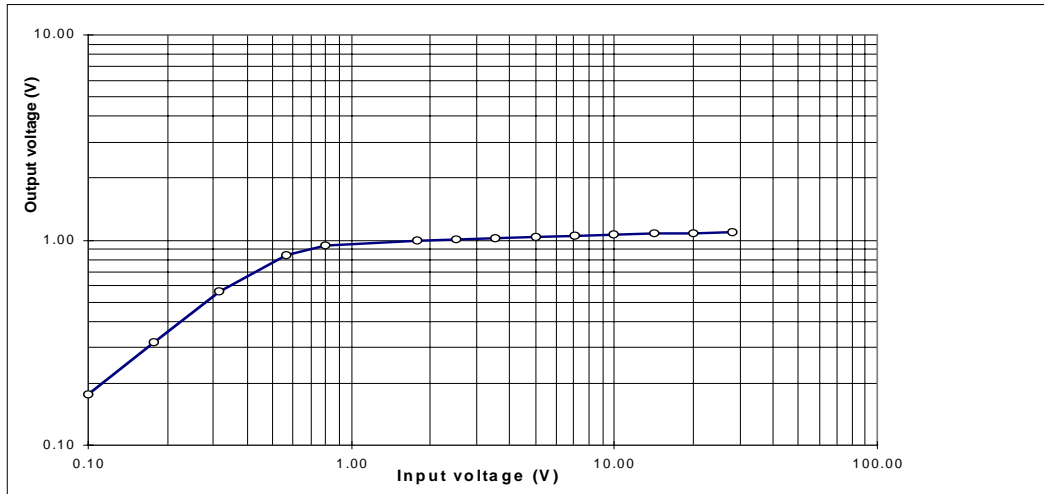

Figure 14-5 Typical performance of an automatic gain control (AGC).

AGC reduces the dynamic range of a signal. This is also known as *compression*. AGC circuits are useful in a number of applications:

- In radio receivers, where the received signal strength may vary quite markedly with time or location, depending on the terrain, propagation effects or distance from the transmitter. It is particularly useful (in fact, essential) with AM transmissions, since the information is actually contained in the (rapid) **variations** of the carrier amplitude. All normal broadcast receivers incorporate some form of AGC (often referred to as *automatic volume control*, or *AVC* in radios), to keep the *average* amplitude constant.
- In portable tape recorders, which have somewhat limited dynamic range, and where manually setting recording levels is time consuming or inconvenient, for example when recording lectures. In this application it's usually referred to as *automatic level control*, or *ALC*.
- In mobile voice communications, where the modulation index needs to be kept high to produce the best S/N ratio and speech intelligibility.



### A radio receiver using the *superheterodyne* technique.

As an example, let's look at how a radio receiver uses some of the various techniques that we have discussed. Most modern radio and TV receivers (whether for AM or FM bands, other frequency ranges, or other modulation methods) use the *superheterodyne* (“*superhet*” for short) technique. This enables important signal processing operations, such as demodulation, to be done at a more convenient lower frequency, rather than at the original high frequency of the incoming signal, as well as providing other advantages.

A block diagram of a superheterodyne receiver for AM is shown below. Let's have a look at the various bits and pieces in this system.

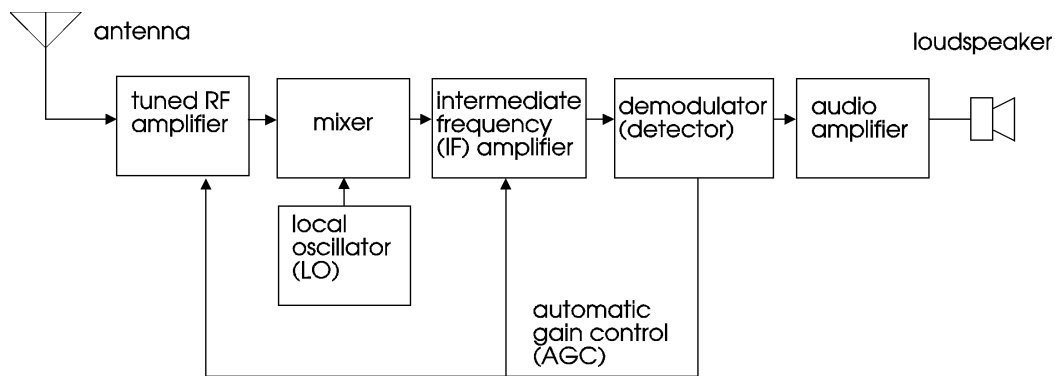

Fig 14-6 Diagram of a superheterodyne receiver for AM. The signal is mixed with a local oscillator (LO) signal and shifted down to an intermediate frequency (IF) before demodulation.

- First, the received (modulated) signal is picked up by an antenna and passed through a *tuned amplifier* –that is, one which also acts as a *bandpass filter*<sup>1</sup> as well as having gain. As well as amplifying the signal, this roughly restricts its frequency range. This first part of the receiver is referred to as the *radio frequency (RF)* stage. The filtering has the effect of attenuating strong signals at other frequencies which might interfere with or overload the receiver’s amplifiers or mixer. To select different stations, the tuning (that is, the centre frequency) of the bandpass filter is varied.
- The next stage is the *mixer*, where the signal is shifted down in frequency. In this stage, the signal from a separate oscillator (called the *local oscillator*, or *LO*) is multiplied by the incoming signal to

<sup>1</sup> You will recall that a bandpass filter only allows a certain range of frequencies to pass through.

produce sum and difference frequencies. The LO frequency is set so that the difference frequency is exactly 455 kHz. This is termed the *intermediate frequency (IF)* and is a standard frequency for AM receivers. (For AM, 470 kHz is also used; for FM receivers the IF is at 10.7 MHz, while in TV receivers it is around 30 MHz).

For example, if the incoming signal is at 1 MHz (1000 kHz), then an LO frequency of 1455 kHz ( $= 1000 + 455$ ) or 545 kHz ( $= 1000 - 455$ ) will produce an IF signal at 455 kHz; usually the higher LO frequency is used. As stations at different frequencies are selected by tuning the RF stage, the frequency of the LO is simultaneously varied, so as to keep the difference frequency at 455 kHz.

- This signal is then passed through an IF amplifier which is more precisely tuned to restrict the range of frequencies. Using a standard frequency for the IF means that no matter what the frequency of the original incoming (RF) signal, it is always processed in pretty much an identical fashion. Note that at this stage the signal still looks like an AM signal –that is, it has a carrier (but now at 455 kHz) and two sidebands.
- The amplified IF signal is then passed to the demodulator (detector), which recovers the original audio information from the carrier.
- An additional dc voltage derived from the detector is used to provide a feedback voltage for automatic gain control, which operates by varying the gain of the IF and/or RF amplifiers, thus keeping the signal level to the demodulator approximately constant.
- Finally, an audio amplifier raises the power of the recovered signal to a sufficient level to drive a loudspeaker.

**Example 14-2:** The AM broadcast band occupies approximately 500 to 1600 kHz. An AM receiver uses an IF frequency of 455 kHz. It is tuned to a station, and its LO frequency is set to 1365 kHz. On what frequency is the station broadcasting?

*Answer:* The IF must be at the sum or difference of the RF and LO frequencies. Hence, the station frequency must be at either  $1365 + 455 = 1820$  kHz, **or**  $1365 - 455 = 910$  kHz, in order to give an IF of 455 kHz. Since 1820 kHz is not in the AM band, the station frequency must be 910 kHz.

**Example 14-3:** An AM receiver uses an IF frequency of 455 kHz. A radio station at 1200 kHz modulates its carrier with a maximum audio frequency of 9 kHz.

- (a) What are the highest and lowest frequency components that are actually broadcast by the station?
- (b) What are the highest and lowest frequencies that must be passed without much loss by the receiver's IF amplifier to recover the original audio signal with full bandwidth?

*Answer:* (a) The highest and lowest frequencies broadcast will correspond to the "outside edges" of the two AM sidebands. These will be at:

$$1200 - 9 = 1191 \text{ kHz} \quad \text{and} \quad 1200 + 9 = 1209 \text{ kHz.}$$

- (b) The original carrier frequency will be shifted down to the IF frequency of 455 kHz by the mixer. Hence the highest and lowest corresponding frequencies which must be passed by the IF amplifier are:

$$455 - 9 = 446 \text{ kHz} \quad \text{and} \quad 455 + 9 = 464 \text{ kHz.}$$

---

**\*Aside:** *Superheterodyne and other "-dynes"*

The rather pretentious-sounding word superheterodyne had its origins in much earlier days of radio, and was short for *supersonic heterodyne*. When two signals were mixed together, the difference frequency was referred to as a *heterodyne*, and supersonic indicates frequencies higher than those we can hear. Various other "dynes", where signals were also mixed together, also arose, such as *homodyne*, *autodyne*, *synchrodyne* and so on. Many of these are now of historical interest only.

---

---

**\*Aside:** *TV signals and receivers*

Compared to an AM radio signal, a TV signal is somewhat more involved and requires a considerably more complex receiver. First, the TV signal consists of two parts:

- The vision signal is amplitude modulated onto a carrier, but most of one sideband is removed before transmission, a technique referred to as *vestigial sideband AM*. This saves RF bandwidth, and since the same information is carried by each sideband anyway in AM, none is lost.
- The sound signal is frequency modulated onto a carrier nearby in frequency, and stereo information is also transmitted (note that we have not covered FM stereo in this course; it is a little more complex than simple “mono” FM).

Second, the vision information itself actually consists of two parts:

- The brightness information or *luminance* (i.e. the “black and white” part of the signal).
- The colour information or *chrominance*.

For those interested, some of this material is covered in the unit ELEC266.

---